



TESTING

TESTA TT TEMPERATURE TESTING

TESTA CT CLIMATIC TESTING

'REACH-IN' ENVIRONMENTAL TEST CHAMBERS





ARALAB is a company specialised in designing, developing, manufacturing and servicing of high quality climatic chambers and controlled environment rooms.

Since 1985 we have been perfecting ways to create and control temperature, humidity, light, air flow and many other environmental conditions.

Only the highest quality components are used to manufacture our chambers so customers can have the best equipment for their research and testing purposes.

Control the Environment. Your Own Climate.



TESTA temperature and humidity testing chambers offer highly precise and reproducible conditions for climatic and temperature testing in many industries.

COMMON APPLICATIONS INCLUDE:

- ENVIRONMENTAL TESTING
- ELECTRONICS, AUTOMOTIVE, AEROSPACE,
- BUILDING MATERIALS, MILITARY EQUIPMENT, MATERIALS IN GENERAL
- RESEARCH & DEVELOPMENT
- QUALITY CONTROL
- PRODUCTION FACILITIES



KEY FEATURES

- The most advanced technology in climate control.
- Internal aerodynamic optimisation to ensure uniformity of climatic conditions.
- Time saving features with easily configurable testing programs that can run, start and stop automatically.
- Highly resistant stainless steel interior for maximum durability and easy cleaning.
- Flexible interior with height adjustable and removable stainless steel shelves.
- Nonpolluting construction and cooling system.
- Compliant with international standards and requirements EN, IEC, DIN, ISO, NP and UNE.



TESTA ENVIRONMENTAL CHAMBERS

TEMPERATURE AND HUMIDITY TESTING CHAMBERS BUILT
TO LAST AND MEET THE MOST DEMANDING STANDARDS.

TESTA CHAMBERS - MODELS AND REFERENCES

● ● ● ● TESTA TT CHAMBERS - TEMPERATURE ONLY

TESTA TT CHAMBERS	TEMPERATURE RANGE	HUMIDITY RANGE
TESTA TT E50	-52°C to +180°C	N/A
TESTA TT E75	-75°C to +180°C	N/A

● ● ● ● TESTA CT CHAMBERS - TEMPERATURE AND HUMIDITY



TESTA CT CHAMBERS	TEMPERATURE RANGE	HUMIDITY RANGE
TESTA CT EP50, EC50 or ECP50	-52°C to +180°C	10 to 98% RH
TESTA CT EP75, EC75 or ECP75	-75°C to +180°C	10 to 98% RH

EC - models with Capacitive humidity sensor
 EP - models with Psychrometric humidity sensor
 ECP - models with both Capacitive and Psychrometric humidity sensors.
 Please consult Aralab if in doubt about the type of sensor to chose





RANGES FOR CLIMATIC AND TEMPERATURE TESTING

● ● ● ● TESTA CT TESTING CHAMBERS

Performance in CLIMATIC testing range | only TESTA CT chambers

TEMPERATURE RANGE		10°C to 95°C
TEMPERATURE UNIFORMITY		± 0,1°C to ± 1,0°C ^(1b)
HUMIDITY RANGE		10% RH to 98% RH

Performance in TEMPERATURE testing | TESTA TT and TESTA CT chambers

TEMPERATURE RANGE		-75°C, or -52°C, up to 180°C
TEMPERATURE UNIFORMITY ^(1a)		± 0,5°C to ± 1,5°C
TEMPERATURE RATE OF CHANGE HEATING ^{(2a) (2b)}		3 versions available: Up to 5K/minute 5k/minute 10k/minute
TEMPERATURE RATE OF CHANGE COOLING ^{(2a) (2b)}		3 versions available: Up to 5K/minute 5k/minute 10k/minute (only for Testa 1000 and above) Higher cooling rates available upon request

Other technical data

NOISE LEVEL		55 to 64 dBA
-------------	---	--------------

Performances measured in factory with ambient temperatures between 20°C and 25°C.

(1a) Measurements at center of test space, with empty chamber and no optional accessories.

(1b) In temperature range up to 150°C.

(2a) According to IEC/EN60068-3-5/6.

(2b) Values will vary with TESTA CT/TESTA TT model, internal volume, compressor type and condenser cooling system. Temperature rate of change can be adjusted to comply with the needed heating / cooling speed requirements. Optional accessories are available for more demanding heating and cooling temperature change rates.

DIMENSIONS AND DRAWINGS

● ● ● ● SYSTEM STRUCTURE

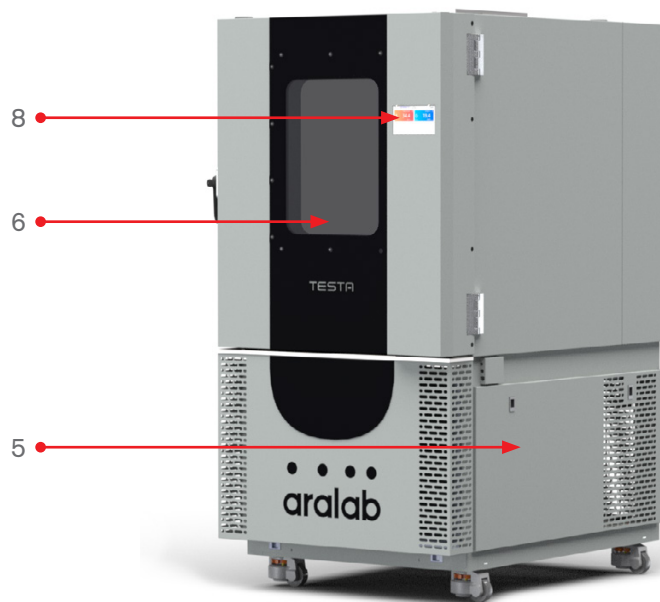
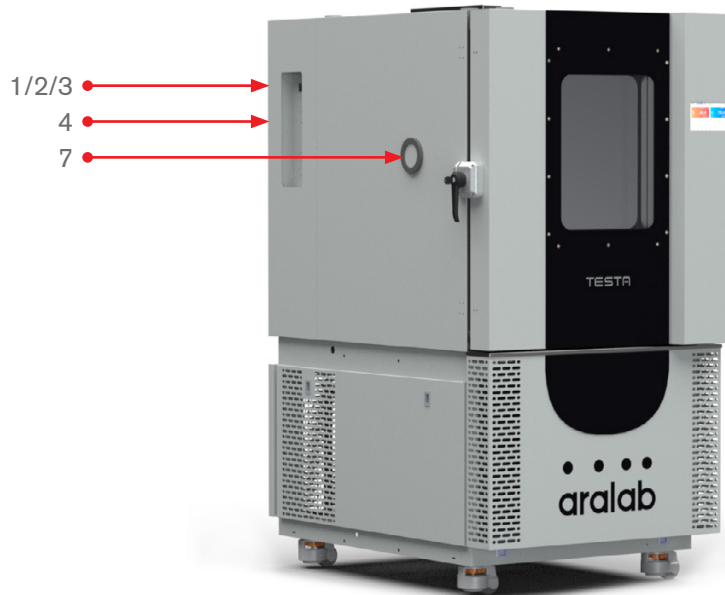

1. Main switch
2. DB9 connector
3. Safety thermostat
4. Electrical Board

5. Machinery compartment
6. Observation window with working light (optional)
7. Entry-port Ø80
8. Touch screen controller

TESTA 300 - PERFORMANCES, DIMENSIONS AND DRAWINGS

● ● ● ● TESTA TT / TESTA CT 300

EXTERNAL DIMENSIONS (HxWxD) (mm)		1 840 x 1 009 x 1 340
INTERNAL DIMENSIONS (HxWxD) (mm)		715 x 634 x 600

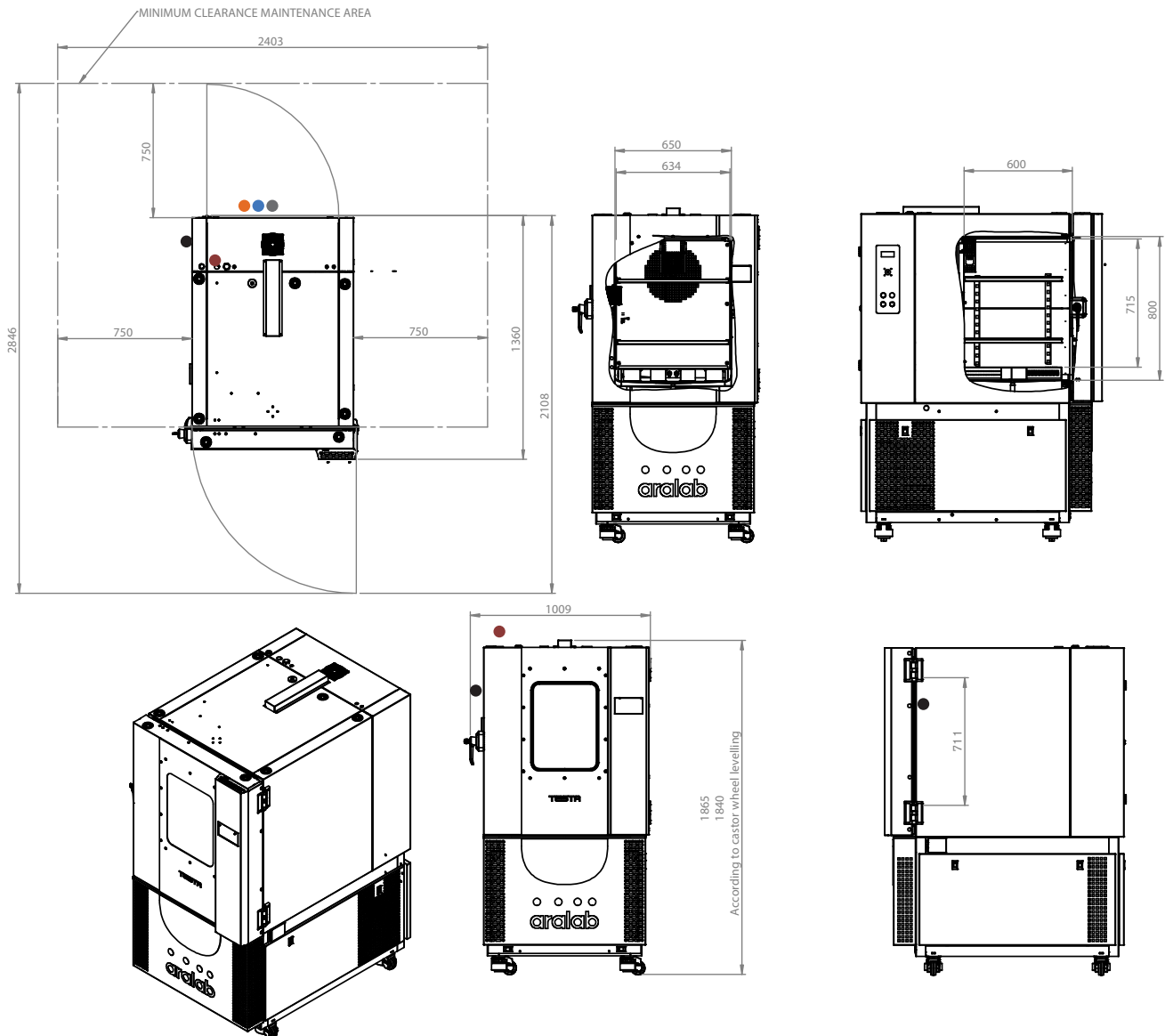

1. **Standard refrigeration system is air cooled**
2. **Services hub installation needs:**
 - 3/4" demineralized water supply
Conductivity: <math>< 50 \mu\text{S}/\text{cm}</math>, TDS <math>< 35\text{PPM}</math>
 - 20mm water drain at floor level female connection
3. **Electrical cabinet installation needs:**

Supply power TESTA 300 TT/CT 50:
400VAC, 50Hz, 16A / 3-Phase + Neutral + Ground
Electrical protection: Circuit breaker 3 x 16A + N with 30mA differential
3-Phase electrical cable RV-K 5G4 on the top

Note: Cooling or Heating rate upgrades can affect Electrical Requirements. Please consult Aralab.

4. **Supply power TESTA 300 TT/CT 75:**
400VAC, 50Hz, 20A / 3-Phase + Neutral + Ground
Electrical protection: Circuit breaker 3 x 32A + N with 30mA differential
3-Phase electrical cable RV-K 5G10 on the top
- **RJ45 communications port**
- **Water cooled option (is included as standard in -75°C models)**
Intake pressure: 3 to 5 bar
Water entry and exit pipe: 1" or 28mm
Maximum temperature of water entry: 23 °C
Minimum temperature of water entry: 16 °C
Recommended temperature of water entry: 18 °C

TESTA CHAMBERS PERFORMANCE	units	Testa TT 300 -50	Testa CT 300 -50	Testa TT 300 -75	Testa CT 300 -75
PERFORMANCE IN TEMPERATURE TESTING					
Temperature range					
Min	°C	-52	-52	-75	-75
Max	°C	180	180	180	180
Temperature uniformity^{(1a) (1b)}					
in Space @ low temp. point	°C	± 0,8	± 0,7	± 0,7	± 1,3
in Space @ +25°C	°C	± 0,1	± 0,2	± 0,2	± 0,2
in Space @ high temp point	°C	± 1,1	± 1,5	± 1,1	± 1,5
Max. According to IEC60068-3-5	°C	± 1,5			
Temperature fluctuation in time	°C	± 0,1°C to ± 0,3°C			
Temperature change rate^{(2a) (2b)}					
cooling	K/min	5,4	5,7	3,5	3,5
heating	K/min	5	5	5	5
PERFORMANCE IN HUMIDITY TESTING					
Humidity range					
Min	%rH	-	10	-	10
Max	%rH	-	98	-	98
Humidity uniformity IEC60068-3-5^{(1a) (1b)}					
in space	%rH	-	± 2	-	± 2
Fluctuation in time	%rH	-	± 1	-	± 1
DIMENSIONS					
Test space volume	liters	272			
Shelves					
number of shelves included (more can be added)	#	2			
maximum weight load per shelf	kg	25			
Entry ports					
Included as standard (more can be added)	units	1			
Diameter (other diameters available)	mm	Ø80			
Weight (approximately)	Kg	535		540	
POWER & REFRIGERATION					
Supply voltage	V	3/N/PE AC 400V±10% 50Hz-60Hz			
Nominal Power	kW	11	11	22	22
Type of Refrigeration^(3c) (air or water cooled)					
Air		Standard		Optional	
Water		Optional		Standard	
Type of Refrigerant^(3c)		R449A		R449A + R23	
Noise levels	dBa	55 to 64 dBA			

Performances measured in factory with ambient temperatures between 20°C and 25°C.

(1a) Measurements at center of test space, with empty chamber and no optional accessories.

(1b) In temperature range up to 150°C.

(2a) According to IEC/EN60068-3-5/6.

(2b) Values will vary with TESTA CT/TESTA TT model, internal volume, compressor type and condenser cooling system. Temperature rate of change can be adjusted to comply with the needed heating / cooling speed requirements. Optional accessories are available for more demanding heating and cooling temperature change rates.

(3c) Other refrigerant gases available.

TESTA 500 PERFORMANCES, DIMENSIONS AND DRAWINGS

● ● ● ● TESTA TT / TESTA CT 500

EXTERNAL DIMENSIONS (HxWxD) (mm)		1 980 x 1 059 x 1 550
INTERNAL DIMENSIONS (HxWxD) (mm)		830 x 680 x 770

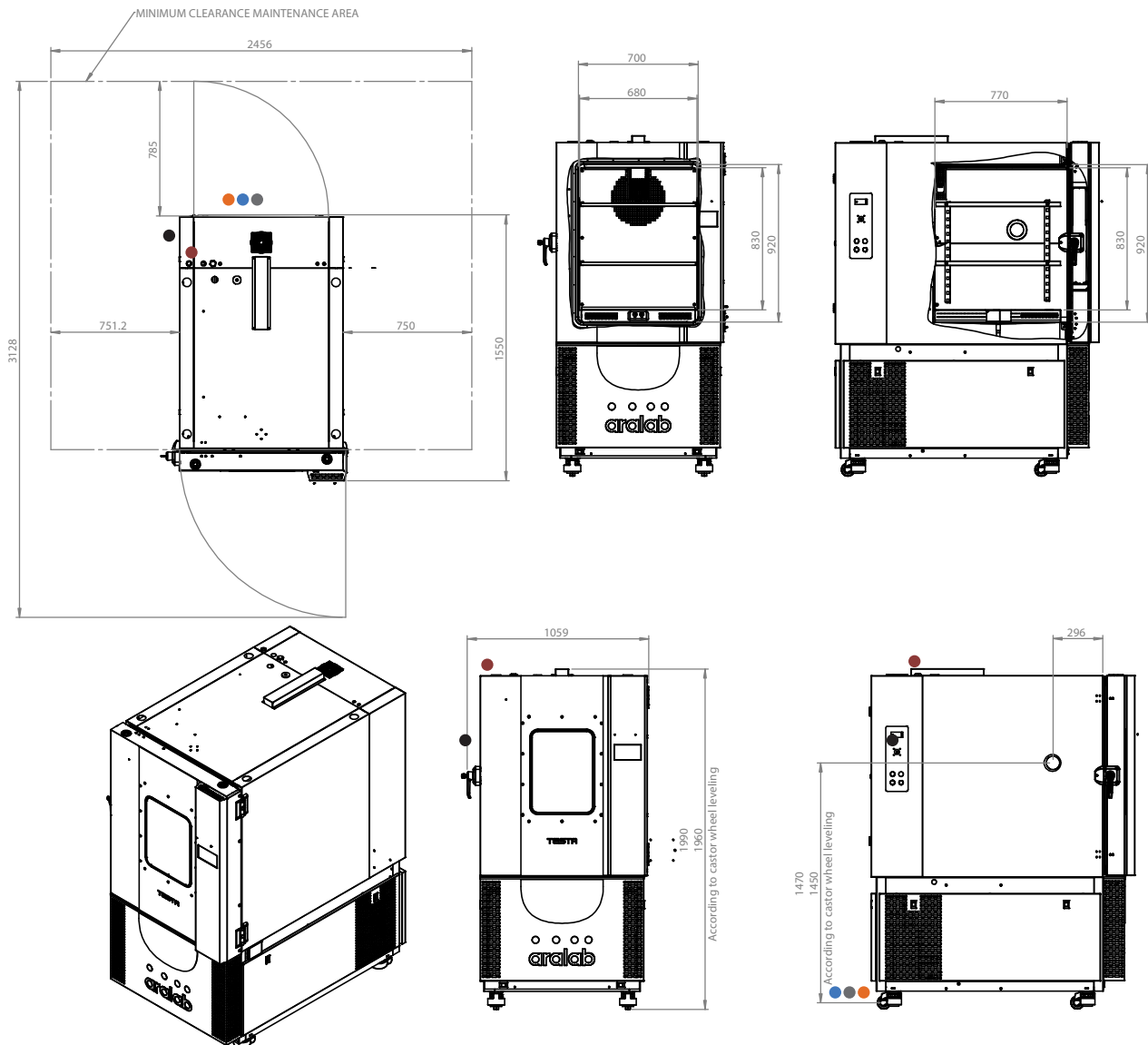

1. **Standard refrigeration system is air cooled**

2. **Services hub installation needs:**

- 3/4" demineralized water supply
- Conductivity: <math>< 50 \mu\text{S}/\text{cm}</math>, TDS <math>< 35\text{PPM}</math>
- 20mm water drain at floor level female connection

3. **Electrical cabinet installation needs:**

Supply power TESTA 500 TT/CT 50:

400VAC, 50Hz, 16A / 3-Phase + Neutral + Ground
 Electrical protection: Circuit breaker 3 x 16A + N with 30mA differential
 3-Phase electrical cable RV-K 5G4 on the top

Supply power TESTA 500 TT/CT 75:

400VAC, 50Hz, 20A / 3-Phase + Neutral + Ground
 Electrical protection: Circuit breaker 3 x 32A + N with 300mA differential
 3-Phase electrical cable RV-K 5G10 on the top

4. **RJ45 communications port**

● **Water cooled option (is included as standard in -75°C models, 5k and 10k models)**

Intake pressure: 3 to 5 bar
 Water entry and exit pipe: 1" or 28mm
 Maximum temperature of water entry: 23 °C
 Minimum temperature of water entry: 16 °C
 Recommended temperature of water entry: 18 °C

TESTA CHAMBERS PERFORMANCE	units	Testa TT 500 -50	Testa CT 500 -50	Testa TT 500 -75	Testa CT 500 -75
PERFORMANCE IN TEMPERATURE TESTING					
Temperature range					
Min	°C	-52	-52	-75	-75
Max	°C	180	180	180	180
Temperature uniformity ^(1a) (1b)					
in Space @ low temp. point	°C	± 0,6	± 0,6	± 1,2	± 1,2
in Space @ +25°C	°C	± 0,2	± 0,2	± 0,1	± 0,1
in Space @ high temp point	°C	± 1,5	± 1,5	± 1,3	± 1,3
Max. According to IEC60068-3-5	°C	± 1,5			
Temperature fluctuation in time	°C	± 0,1°C to ± 0,3°C			
Temperature change rate ^(2a) (2b)					
cooling	K/min	5,4	5	3,5	3
heating	K/min	4	4	4,5	4,5
PERFORMANCE IN HUMIDITY TESTING					
Humidity range					
Min	%rH	-	10	-	10
Max	%rH	-	98	-	98
Humidity uniformity IEC60068-3-5 ^(1a) (1b)					
in space	%rH	-	± 2	-	± 2
Fluctuation in time	%rH	-	± 1	-	± 1
DIMENSIONS					
Test space volume	liters	455			
Shelves					
number of shelves included (more can be added)	#	2			
maximum weight load per shelf	kg	25			
Entry ports					
Included as standard (more can be added)	units	1			
Diameter (other diameters available)	mm	Ø80			
Weight (approximately)	Kg	584	600		
POWER & REFRIGERATION					
Supply voltage	V	3/N/PE AC 400V±10% 50Hz-60Hz			
Nominal Power	kW	11	11	22	22
Type of Refrigeration ^(3c) (air or water cooled)					
Air		Standard		Optional	
Water		Optional		Standard	
Type of Refrigerant ^(3c)		R449A		R449A + R23	
Noise levels	dBa	55 to 64 dBA			

Performances measured in factory with ambient temperatures between 20°C and 25°C.

(1a) Measurements at center of test space, with empty chamber and no optional accessories.

(1b) In temperature range up to 150°C.

(2a) According to IEC/EN60068-3-5/6.

(2b) Values will vary with TESTA CT/TESTA TT model, internal volume, compressor type and condenser cooling system. Temperature rate of change can be adjusted to comply with the needed heating / cooling speed requirements. Optional accessories are available for more demanding heating and cooling temperature change rates.

(3c) Other refrigerant gases available.

TESTA 1.000 PERFORMANCES, DIMENSIONS AND DRAWINGS

● ● ● ● TESTA TT / TESTA CT 1.000

EXTERNAL DIMENSIONS (HxWxD) (mm)		2 010 x 1 359 x 1 845
INTERNAL DIMENSIONS (HxWxD) (mm)		910 x 984 x 1 052

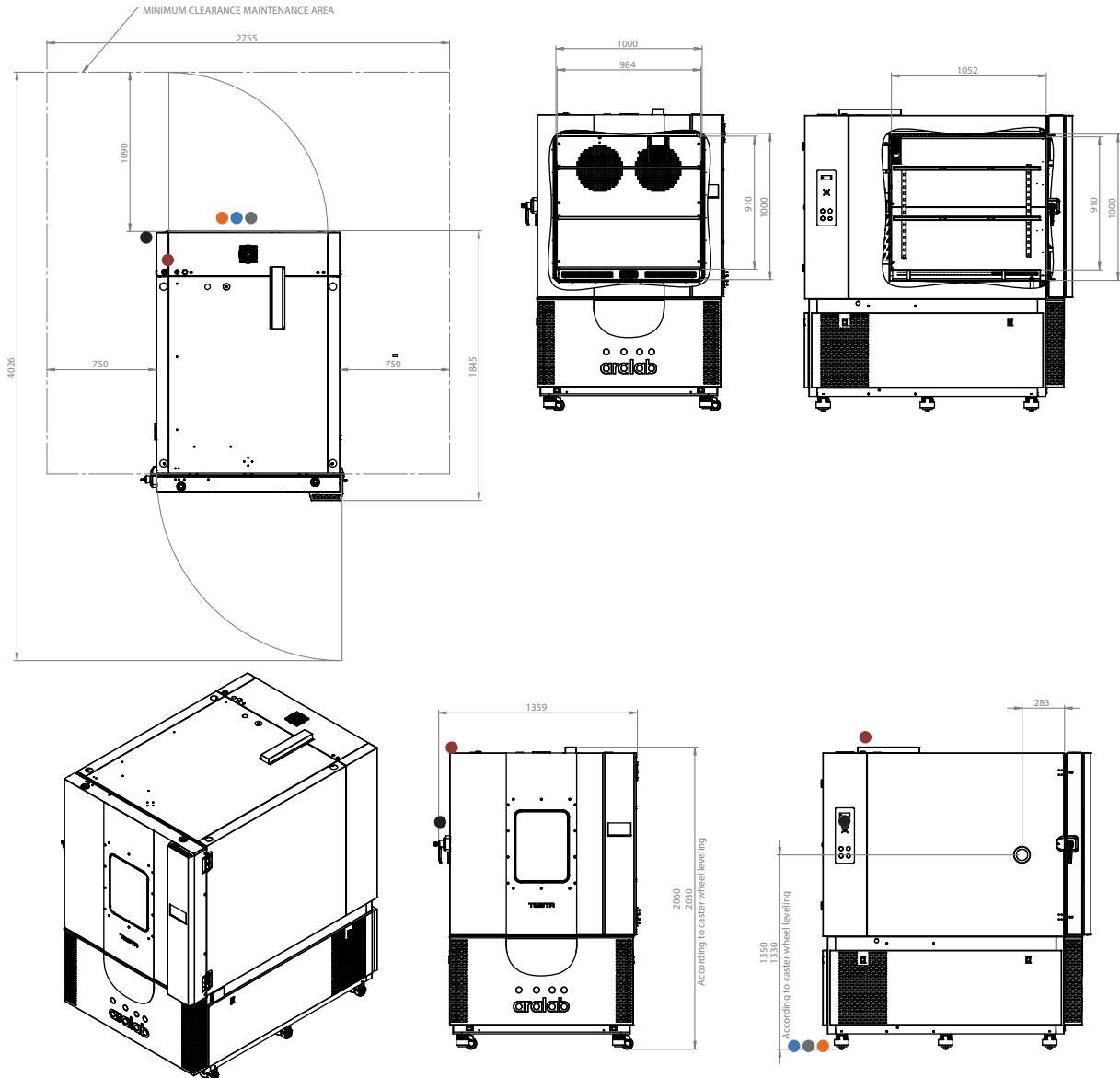

- | | |
|---|--|
| <ol style="list-style-type: none"> Standard refrigeration system is air cooled Services hub installation needs: <ul style="list-style-type: none"> ● 3/4" demineralized water supply Conductivity: <math>< 50 \mu\text{S}/\text{cm}</math>, TDS <math>< 35\text{PPM}</math> ● 20mm water drain at floor level female connection Electrical cabinet installation needs: <ul style="list-style-type: none"> ● Supply power TESTA 1000 TT/CT 50:
400VAC, 50Hz, 32A / 3-Phase + Neutral + Ground
Electrical protection: Circuit breaker 3 x 32A + N with 30mA differential
3-Phase electrical cable RV-K 5G4 on the top | <ol style="list-style-type: none"> <ul style="list-style-type: none"> ● Supply power TESTA 1000 TT/CT 75 and 10K model:
400VAC, 50Hz, 50A / 3 Phase + Neutral + Ground
Electrical protection: Circuit breaker 3 x 63A + N with 300mA differential
3-Phase electrical cable RV-K 5G10 on the top ● RJ45 communications port ● Water cooled option (is included as standard in -75°C models, 5k and 10k models)
Intake pressure: 3 to 5 bar
Water entry and exit pipe: 1" or 28mm
Maximum temperature of water entry: 23 °C
Minimum temperature of water entry: 16 °C
Recommended temperature of water entry: 18 °C |
|---|--|

TESTA CHAMBERS PERFORMANCE	units	Testa TT 1.000 -50	Testa CT 1.000 -50	Testa TT 1.000 -75 (-40 10k)	Testa CT 1.000 -75 (-40 10k)	Testa TT 1.000 -75	Testa CT 1.000 -75
PERFORMANCE IN TEMPERATURE TESTING							
Temperature range							
Min	°C	-52	-52	-75	-75	-75	-75
Max	°C	180	180	180	180	180	180
Temperature uniformity^{(1a) (1b)}							
in Space @ low temp. point	°C	± 0,7	± 0,7	± 0,7	± 0,7	± 1,2	± 1,2
in Space @ +25°C	°C	± 0,3	± 0,3	± 0,3	± 0,3	± 0,3	± 0,1
in Space @ high temp point	°C	± 1,4	± 1,5	± 1,5	± 1,5	± 1,5	± 1,5
Max. According to IEC60068-3-5	°C	± 1,5					
Temperature fluctuation in time	°C	± 0,1°C to ± 0,3°C			± 0,1°C to ± 0,3°C		
Temperature change rate^{(2a) (2b)}				Calculated in the 180°C to -40°C range		Calculated in the 180°C to -75°C range	
cooling	K/min	5,1	5,1	10	10	4	4
heating	K/min	6	6	10	10	4,5	4,5
PERFORMANCE IN HUMIDITY TESTING							
Humidity range							
Min	%rH	-	10	-	10	-	10
Max	%rH	-	98	-	98	-	98
Humidity uniformity IEC60068-3-5^{(1a)(1b)}							
in space	%rH	-	± 2	-	± 2	-	± 2
Fluctuation in time	%rH	-	± 1	-	± 1	-	± 1
DIMENSIONS							
Test space volume	liters	967			967		
Shelves							
number of shelves included (more can be added)	#	2			2		
maximum weight load per shelf	kg	50		25		50	
Entry ports							
Included as standard (more can be added)	units	1			1		
Diameter (other diameters available)	mm	Ø80			Ø80		
Weight (approximately)	Kg	874		910		910	
POWER & REFRIGERATION							
Supply voltage	V	3/N/PE AC 400V±10% 50Hz-60Hz			3/N/PE AC 400V±10% 50Hz-60Hz		
Nominal Power	kW	22	22	44	44	35	35
Type of Refrigeration^(3c) (air or water cooled)							
Air		Standard			N/A		Optional
Water		Optional		Standard		Standard	
Type of Refrigerant^(3c)		R449A			R449A + R23		
Noise levels	dBA	55 to 64 dBA			55 to 64 dBA		

Performances measured in factory with ambient temperatures between 20°C and 25°C.

(1a) Measurements at center of test space, with empty chamber and no optional accessories. (1b) In temperature range up to 150°C;

(2a) According to IEC/EN60068-3-5/6.

(2b) Values will vary with TESTA CT/TESTA TT model, internal volume, compressor type and condenser cooling system. Temperature rate of change can be adjusted to comply with the needed heating / cooling speed requirements. Optional accessories are available for more demanding heating and cooling temperature change rates.

(3c) Other refrigerant gases available.

TESTA 1.500 PERFORMANCES, DIMENSIONS AND DRAWINGS

● ● ● ● TESTA TT TESTA CT 1.500

EXTERNAL DIMENSIONS (HxWxD) (mm)		2 050 x 1 359 x 2 346
INTERNAL DIMENSIONS (HxWxD) (mm)		909 x 984 x 1 555

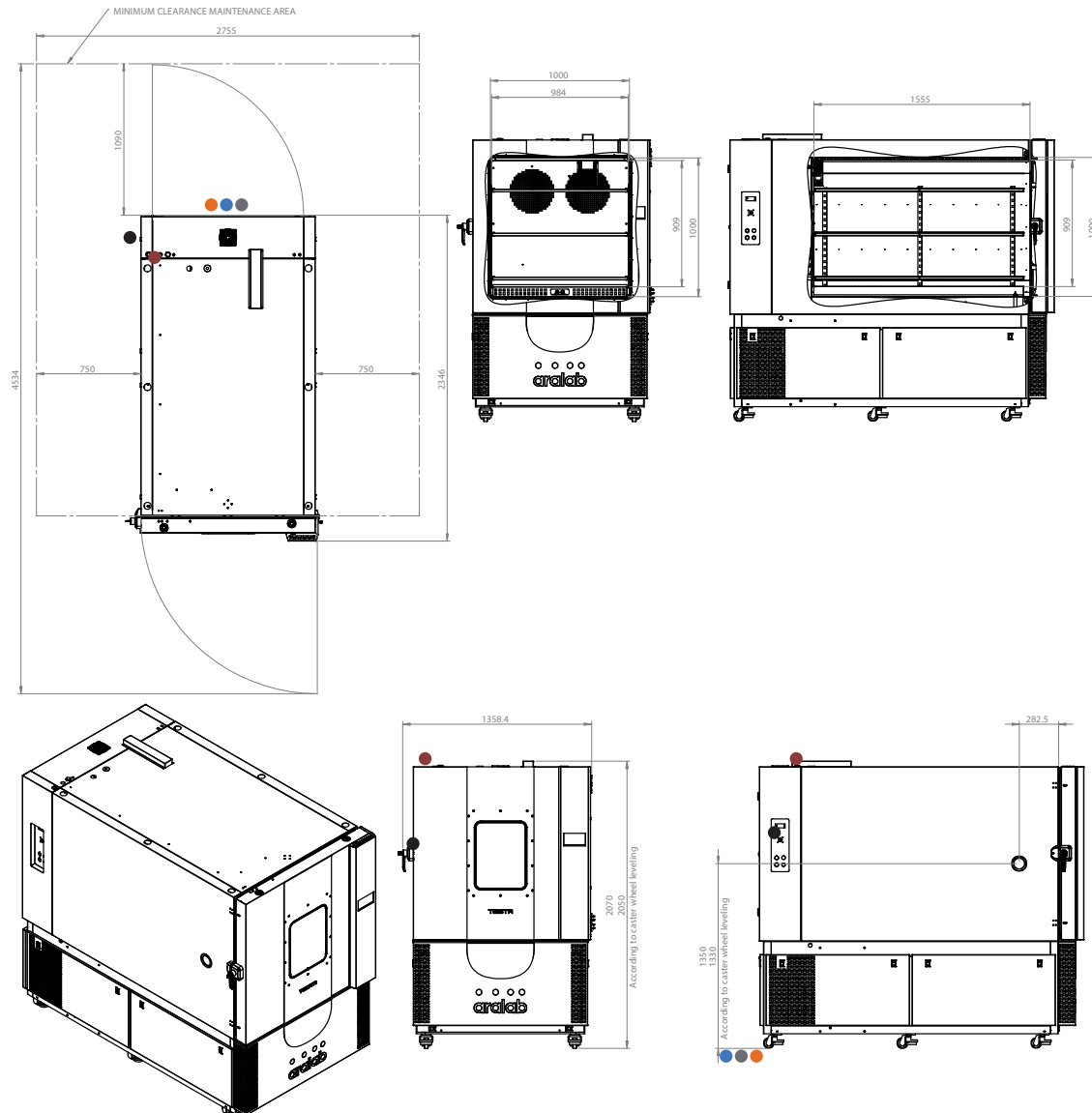

- Standard refrigeration system is air cooled**
- Services hub installation needs:**
 - 3/4" demineralized water supply
Conductivity: <math>< 50 \mu\text{S}/\text{cm}</math>, TDS <math>< 35\text{PPM}</math>
 - 20mm water drain at floor level female connection
- Electrical cabinet installation needs:**
 - Supply power TESTA 1500 TT/CT 50:**
400VAC, 50Hz, 32A / 3-Phase + Neutral + Ground
Electrical protection: Circuit breaker 3 x 32A + N with 30mA differential
3-Phase electrical cable RV-K 5G4 on the top
 - Supply power TESTA 1500 TT/CT 75:**
400VAC, 50Hz, 50A / 3 Phase + Neutral + Ground
Electrical protection: Circuit breaker 3 x 63A + N with 300mA differential
3-Phase electrical cable RV-K 5G10 on the top
- RJ45 communications port**
 - **Water cooled option (is included as standard in -75°C models, 5k and 10k models)**
Intake pressure: 3 to 5 bar
Water entry and exit pipe: 1" or 28mm
Maximum temperature of water entry: 23 °C
Minimum temperature of water entry: 16 °C
Recommended temperature of water entry: 18 °C

TESTA CHAMBERS PERFORMANCE	units	Testa TT 1.500 -50	Testa CT 1.500 -50	Testa TT 1.500 -75	Testa CT 1.500 -75
PERFORMANCE IN TEMPERATURE TESTING					
Temperature range					
Min	°C	-52	-52	-75	-75
Max	°C	180	180	180	180
Temperature uniformity^{(1a)(1b)}					
in Space @ low temp. point	°C	± 0,3	± 0,3	± 0,9	± 0,9
in Space @ +25°C	°C	± 0,2	± 0,2	± 0,2	± 0,2
in Space @ high temp point	°C	± 1,5	± 1,5	± 1,5	± 1,5
Max. According to IEC60068-3-5	°C	± 1,5			
Temperature fluctuation in time	°C	± 0,1°C to ± 0,3°C			
Temperature change rate^{(2a) (2b)}					
cooling	K/min	4	4	3,5	3,5
heating	K/min	4	4	4,5	4,5
PERFORMANCE IN HUMIDITY TESTING					
Humidity range					
Min	%rH	-	10	-	10
Max	%rH	-	98	-	98
Humidity uniformity IEC60068-3-5^{(1a)(1b)}					
in space	%rH	-	± 2	-	± 2
Fluctuation in time	%rH	-	± 1	-	± 1
DIMENSIONS					
Test space volume	liters	1411			
Shelves					
number of shelves included (more can be added)	#	2			
maximum weight load per shelf	kg	50			
Entry ports					
Included as standard (more can be added)	units	1			
Diameter (other diameters available)	mm	Ø80			
Weight (approximately)	Kg	1175		1220	
POWER & REFRIGERATION					
Supply voltage	V	3/N/PE AC 400V±10% 50Hz-60Hz			
Nominal Power	kW	17	22	35	35
Type of Refrigeration^(3c) (air or water cooled)					
Air		Standard		Optional	
Water		Optional		Standard	
Type of Refrigerant^(3c)		R449A		R449A + R23	
Noise levels	dBA	55 to 64 dBA			

Performances measured in factory with ambient temperatures between 20°C and 25°C.

(1a) Measurements at center of test space, with empty chamber and no optional accessories.

(1b) In temperature range up to 150°C.

(2a) According to IEC/EN60068-3-5/6.

(2b) Values will vary with TESTA CT/TESTA TT model, internal volume, compressor type and condenser cooling system. Temperature rate of change can be adjusted to comply with the needed heating / cooling speed requirements. Optional accessories are available for more demanding heating and cooling temperature change rates.

(3c) Other refrigerant gases available.





TESTA 2.000 PERFORMANCES, DIMENSIONS AND DRAWINGS

● ● ● ● TESTA TT TESTA CT 2.000

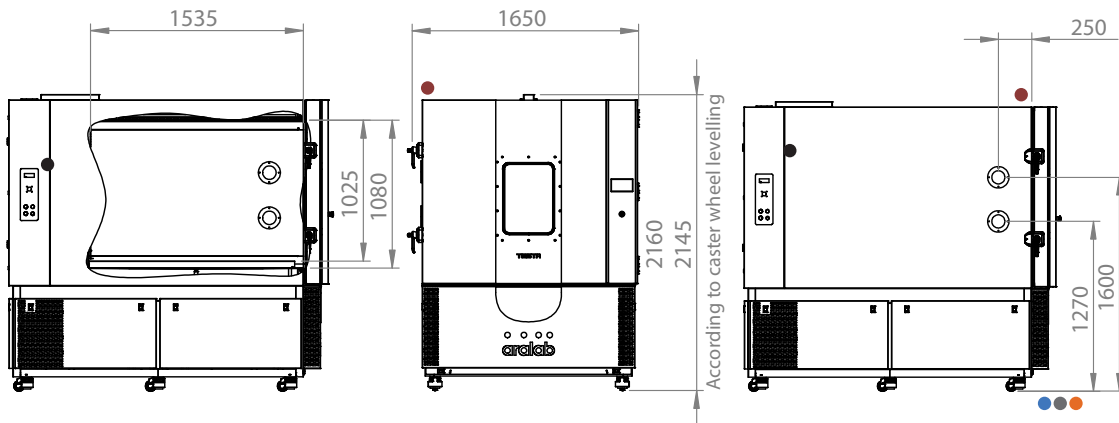
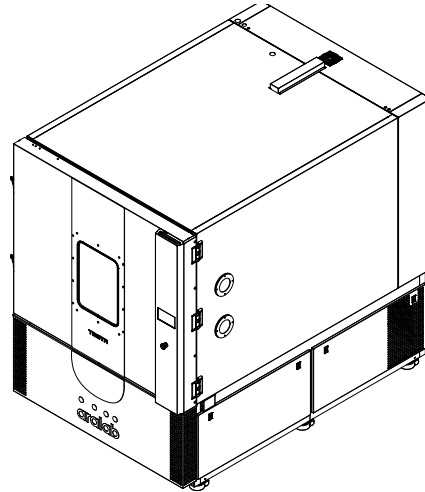
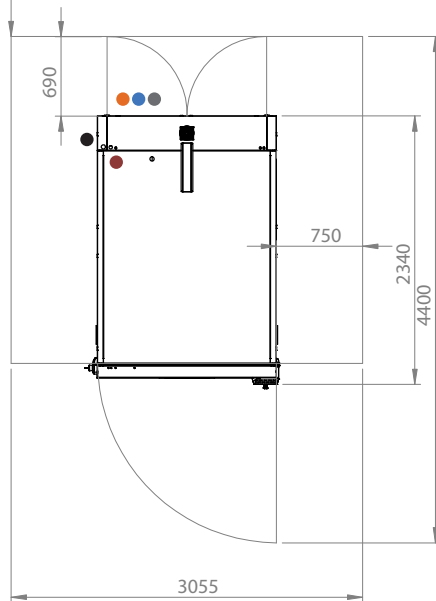
EXTERNAL DIMENSIONS (HxWxD) (mm)		2 145 x 1 650 x 2 340
INTERNAL DIMENSIONS (HxWxD) (mm)		1 050 x 1 280 x 1 535

MINIMUM CLEARANCE
MAINTENANCE AREA



- | | |
|---|---|
| <ol style="list-style-type: none"> Standard refrigeration system is air cooled Services hub installation needs: <ul style="list-style-type: none">  3/4" demineralized water supply
Conductivity: <math>< 50 \mu\text{S}/\text{cm}</math>, TDS <math>< 35\text{PPM}</math>  20mm water drain at floor level female connection  Electrical cabinet installation needs:
Supply power TESTA 2000 TT/CT 60:
400VAC, 50Hz, 50A / 3 Phase + Neutral + Ground
Electrical protection: Circuit breaker 3 x 63A + N with 30mA differential
3-Phase electrical cable RV-K 5G10 on the top | <ol style="list-style-type: none">  RJ45 communications port  Water cooled option (is included as standard in -60°C models, 5k and 7k models)
Intake pressure: 3 to 5 bar
Water entry and exit pipe: 1" or 28mm
Maximum temperature of water entry: 23 °C
Minimum temperature of water entry: 16 °C
Recommended temperature of water entry: 18 °C |
|---|---|

TESTA CHAMBERS PERFORMANCE	units	Testa TT 2.000 -60	Testa CT 2.000 -60	Testa TT 2.000 -60 (-40 7K)	Testa CT 2.000 -60 (-40 7k)
PERFORMANCE IN TEMPERATURE TESTING					
Temperature range					
Min	°C	-60	-60	-60	-60
Max	°C	180	180	180	180
Temperature uniformity^{(1a)(1b)}					
in Space @ low temp. point	°C	± 0,9	± 0,9	± 0,9	± 0,9
in Space @ +25°C	°C	± 0,2	± 0,2	± 0,2	± 0,2
in Space @ high temp point	°C	± 1,5	± 1,5	± 1,5	± 1,5
Max. According to IEC60068-3-5	°C	± 1,5		± 1,5	
Temperature fluctuation in time	°C	± 0,1°C to ± 0,5°C		± 0,1°C to ± 0,5°C	
Temperature change rate^{(2a) (2b)}				Calculated in the 180°C to -40°C range	
cooling	K/min	4	4	7	7
heating	K/min	4	4	7	7
PERFORMANCE IN HUMIDITY TESTING					
Humidity range					
Min	%rH	-	10	-	10
Max	%rH	-	98	-	98
Humidity uniformity IEC60068-3-5^{(1a)(1b)}					
in space	%rH	-	± 2	-	± 2
Fluctuation in time	%rH	-	± 1	-	± 1
DIMENSIONS					
Test space volume	liters	2000		2000	
Shelves					
number of shelves included (more can be added)	#	2		2	
maximum weight load per shelf	kg	50		50	
Entry ports					
Included as standard (more can be added)	units	1		1	
Diameter (other diameters available)	mm	Ø80		Ø80	
Weight (approximately)	Kg	1500		1500	
POWER & REFRIGERATION					
Supply voltage	V	3/N/PE AC 400V 50Hz-60Hz		3/N/PE AC 400V 50Hz-60Hz	
Nominal Power	kW	44		44	
Type of Refrigeration^(3c) (air or water cooled)					
Air		N/A		N/A	
Water		Standard		Standard	
Type of Refrigerant^(3c)		R449A + R23 + R290 ⁽³⁾		R449A + R23	
Noise levels	dBA	55 to 64 dBA		55 to 64 dBA	

Performances measured in factory with ambient temperatures between 20°C and 25°C.

(1a) Measurements at center of test space, with empty chamber and no optional accessories; (1b) in temperature range up to 150°C.

(2a) According to IEC/EN60068-3-5/6.

(2b) Values will vary with TESTA CT/TESTA TT model, internal volume, compressor type and condenser cooling system. Temperature rate of change can be adjusted to comply with the needed heating / cooling speed requirements. Optional accessories are available for more demanding heating and cooling temperature change rates.

(3c) Other refrigerant gases available.

EQUIPMENT DESCRIPTION

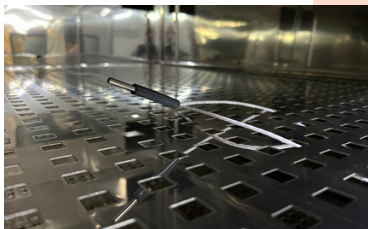

TEMPERATURE

TEMPERATURE SENSORS

- One (1) PT 100 Class A
- One (1) PT 100 Class A, movable sensors for flexible placing inside chamber

HEATING

- By stainless steel electric heaters located in the air treatment tunnel

COOLING

- Air cooled hermetic compressor group (low noise and high efficiency) with enforced ventilation and without CFC's. Water-cooled condensers are also available as standard in -75°C models or an option for models with temperature cooling rate upgrades.

THERMAL SECURITY

- Safety thermostat with High / Low temperature configuration, with automatic stop of all thermic systems.
- High / Low temperature alarms programmed in the controller, with mute function. This function will not stop the chamber and it is only used to record the occurrence and to call the attention of the users with an audible alarm.



HUMIDITY (TESTA CT CHAMBERS)

HUMIDITY SENSORS

- To measure and control humidity Aralab uses two different sensor technologies: Psychrometric (EP models), Capacitive (EC models), or both (ECP models). Consult Aralab for technical support on the appropriate selection.

HUMIDITY / DRYING

- Humidity: Through thermostatic bath with dew point control
- Drying: Through thermostatic bath with dew point control and additional dry coil

HUMIDITY SENSORS: HUMIDITY VS. TEMPERATURE RANGES GRAPHIC

- For climatic tests that require humidity and temperature ranges highlighted in red on the graph, a Psychrometric sensor is recommended (EP and ECP models). Please consult Aralab for help on the choice between these two models.

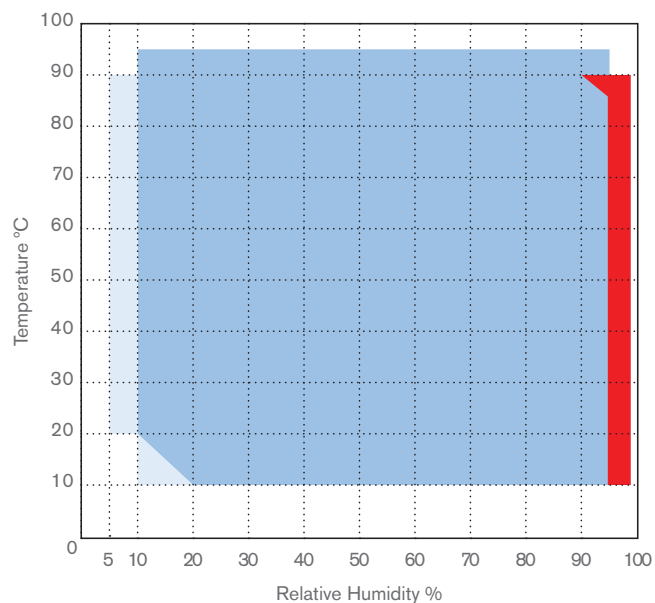

- Standard Climatic range 10%-98%rH and 10°C-95°C (in TESTA 1.000 to 2.000)
- Climatic range with upgraded drying capacity (please consult Aralab)
- Climatic range suitable for psychrometric sensor >95%rH

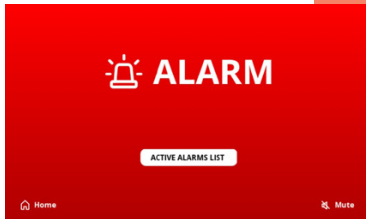

SECURITY

- Automatic stop function in case of water failure, with indication on the controller; High / Low Temperature alarms; High / Low humidity alarms.



CONSTRUCTION

- Interior: AISI 304 hermetical welded, vapour tight, stainless steel
- Exterior: Zinc mild steel with epoxy coating finish (color RAL 7035)
- Insulation: Rock Wool
- Interior illumination: Included with Optional Observation Window
- Door: Double silicone joints and anti-condensation heating frames (optional window)



AIR FLOW / VENTILATION

- Air Flow: Forced through ventilators/fans (300 and 500 models have one ventilator/fan, 1.000 and 1.500 models have two, and TESTA 2000 has 3).
- Air Renovation: By lateral port, also for compensating pressure.

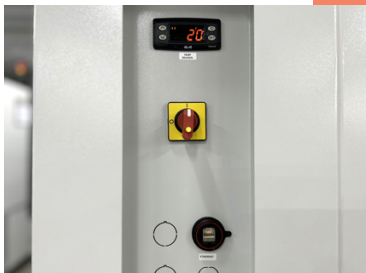

CUT-OFF PANEL, SECURITY AND COMMUNICATIONS

On left lateral panel of the chamber and equipped with:

- High / Low safety thermostat
- Mains Power switch
- Audible alarms
- Ethernet communications port

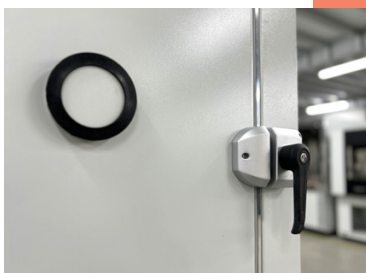

INCLUSIONS

- 2 Stainless steel shelves
- Lockable door
- 1 left side entry port with Ø 80 mm (more can be added)
- 4 or 6 height leveling casters (model dependent)
- Instructions manual
- 2 years' warranty

CLIMAPLUS HMI WEB CONTROLLER

Programmable PLC exclusively developed for Aralab chambers.

Easy to use coloured Touch-Screen Display Interface.

Resolution of 0,1°C for Temperature and 0,1% for Relative Humidity.

High performance temperature and humidity control with value correction in all ranges.

Capability for creating unlimited programs and segments.

Internal non volatile memory for storing test data.

Automatic restart of tests due to power failure, without losing data and restarting test where it was interrupted.

Real-time monitoring of all functions and control of equipment.

Manage control settings via MODBUS/TCP.

Possibility of programming a delay of the beginning of test.

Monitoring and recording of all alarms.

Possibility of performing events by external commands.

Several outputs for connecting computers or other devices.

Alarms management.

Graphic representation of the tests and conditions.

Remote access through VNC server.

Possibility of running computer test programs and export them to the controller.

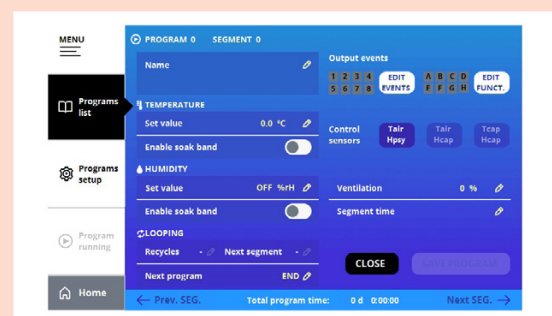
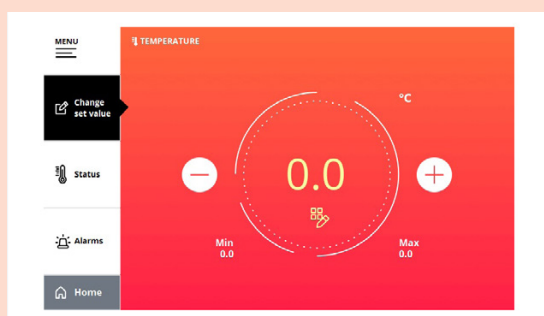
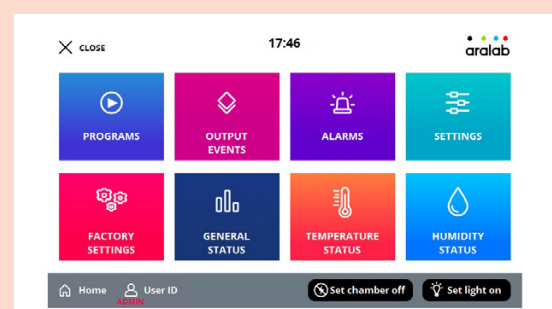
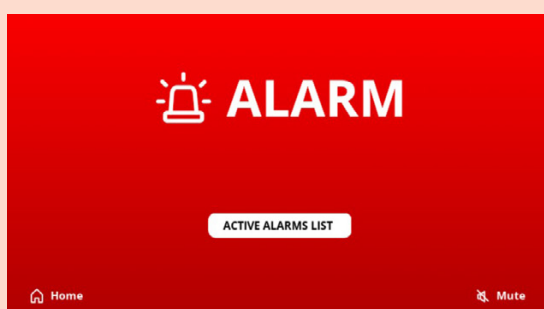

FITOLOG SOFTWARE

The FitoLog software pack is a set of applications designed to facilitate the managing, monitoring and recording of programs and data from the TESTA chambers. It consists of 3 applications: **FitoLog**, **FitoLogView** and **FitoProgram**.



FITOLOG

Records and displays in real time all data and details related to the set-points, running variables and equipment behaviour. It also retrieves information about the active components of the chamber, running processes, errors, alarms and allows the configuration of periodic or alarm triggered remote notifications (by email or SMS, depending on existing connections and accessories).



FITOLOGVIEW

It is a working tool to process the data recorded by the FitoLog program. One can view, print and export the log contents to other file types, and analyse the data in other data management software.

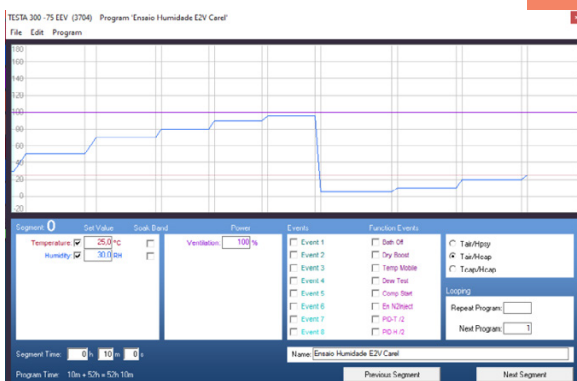

FITOPROGRAM

This application simplifies the creation of programs and its integration on the chamber ClimaPlus controller. Unlimited programs and segments, can be designed and linked to create detailed environmental profiles and simulations.

NOTIFICATIONS, FAST DIAGNOSTICS AND PROMPT TROUBLESHOOTING

With FitoLog it is possible to gather data from each of the chambers systems, which makes it a very useful tool to diagnose any necessary maintenance. This tool works as the "black box" of the equipment, giving Aralab technicians the necessary data to remotely carry out a fast and efficient diagnostic. All that is needed is a FitoLog file.

ACCESSORIES AND APPLICATIONS



Door with observation window



Compressed Air Dryer



Additional Entry-ports



Cold Bend Cables Testing

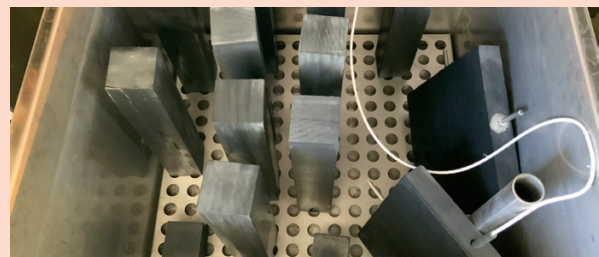

Freeze-Thaw test tank



Electronic safety locks



Gas Sensors



EUCAR Battery testing

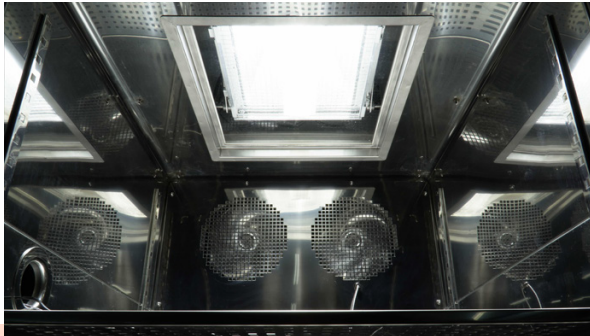

Solar and UV radiation simulation

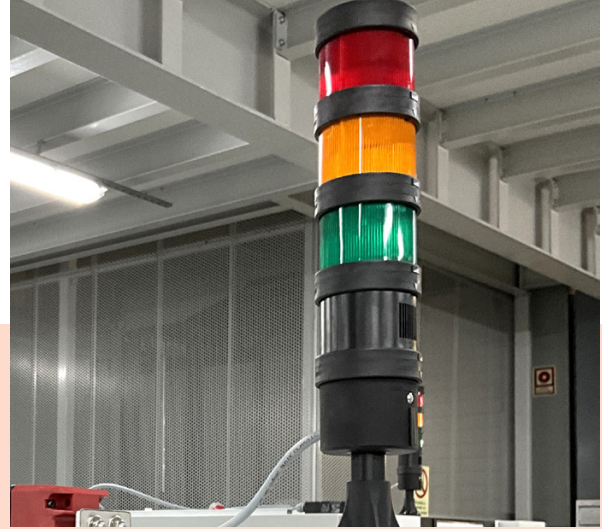

Safety stack light status indicator



Water supply tank

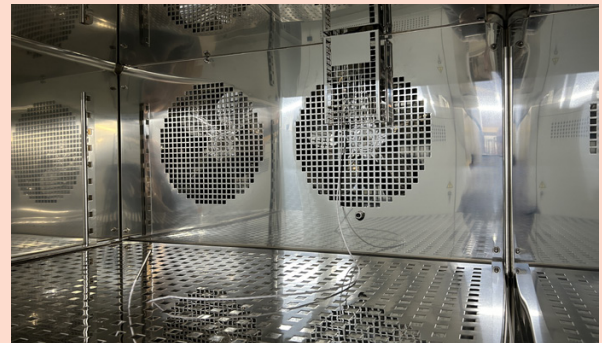

Reinforced Shelves (up to 100 Kg load)



Rain simulation sprinklers



Shaker Integrations for vibration testing



Latex gloves ports



Water Treatment systems

Let's meet!

aralab@aralab.pt

www.aralab.pt

T: +351 219 154 960



Configure your chamber 

See it on the Showroom 

 /AralabChambers

 /company/aralab

 /user/AralabChambers

 /Aralab_

 /aralabchambers



Control the environment

Your own climate