



STABILITY

STABILCLIMA

WALK-IN STABILITY

CONTROLLED ENVIRONMENT ROOMS WITH TEMPERATURE, HUMIDITY AND AIRFLOW CONTROL. READY FOR STABILITY STUDIES, SHELF-LIFE OR PACKAGE TESTING.

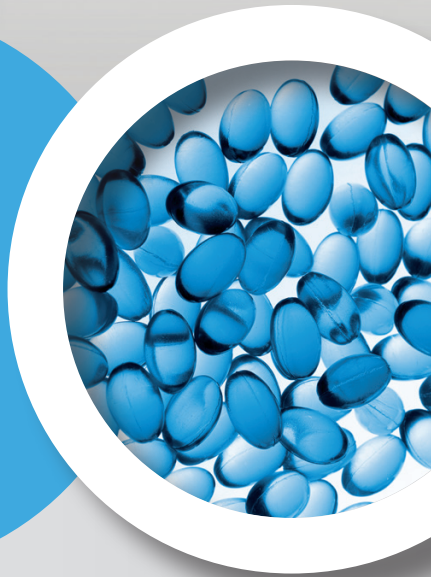

ICH, GMP, WHO, FDA COMPLIANT





ARALAB is a company specialized in designing, developing, manufacturing and servicing of high quality climatic chambers and controlled environment rooms.

Since 1985 we have been perfecting ways to create and control temperature, humidity, light, air flow and many other environmental conditions.

Only the highest quality components are used to manufacture our chambers so customers can have the best equipment for their research and testing purposes.

Control the Environment. Your Own Climate.



StabilClima Stability rooms provide the environmental control and storage flexibility to meet the evolving needs of customers throughout the years.

COMMON APPLICATIONS INCLUDE:

- ICH STABILITY TESTING
- PHARMACEUTICALS
- FOOD AND BEVERAGES
- COSMETICS
- VETERINARY
- STORAGE AND CONSERVATION
- QUALITY CONTROL AND RESEARCH



KEY FEATURES

- Environmental conditions controlled with consistent precision through the years.
- Pre-configured with shelves designed to provide an efficient use of the internal volume.
- Adaptive future proof design, with height adjustable trays and shelves that are easy to insert or remove depending on storage needs.
- Content protection features, with configurable high / low temperature and humidity alarms and automatic remote notifications.
- FDA 21 CFR part 11 compliant software (Gamp5).
- Compliant and recognized by ICH, FDA, GMP and other leading industry standards.
- IQ, OQ, PQ and ISO calibration documents.



TECHNICAL SPECIFICATIONS

● ● ● ● TECHNICAL DATA FOR STABILCLIMA WALK-IN STABILITY CHAMBERS

TEMPERATURE RANGE ^[1]		15°C to 45°C
TEMPERATURE FLUCTUATION IN TIME ^[2]		± 0,5°C
TEMPERATURE UNIFORMITY IN SPACE ^[2]		± 1,0°C
HUMIDITY RANGE ^[1]		20% to 90% rH
HUMIDITY FLUCTUATION IN TIME ^[2]		± 1% rH
HUMIDITY UNIFORMITY IN SPACE ^[2]		± 2% rH
SHELVES AND TRAYS ^[3]		Modular shelving structures made of anodized aluminium with polyethylene shelves are included with the chambers. Each module has 5 tiers/levels of shelves. Storage capacity will vary with final implementation layout and number tiers/levels on each module. Additional tiers of shelves can be added to increase total storage capacity. Maximum weight load of 150Kg per shelf (evenly distributed).
APPROXIMATE STORAGE CAPACITY ^[4] StabilClima 5 000 PH StabilClima 12 000 PH StabilClima 20 000PH StabilClima 25 000 PH		10 m ² 19 m ² 29 m ² 32 m ²
LIGHT		Recessed LED lights installed at the ceiling. Light can be operated by manual switch, triggered by door opening or controller integrated (programmable)
AIRFLOW VELOCITY		Can be adjusted by set-point % on the controller
INTERNAL VOLUMES ^[5]		Ranging from 5 000 to 25 000 liters

[1] Temperature range extension available from 5°C to 45°C. Please contact Aralab for other technical requirements.

[2] IEC60068-3-5/6

[3] Aralab Stability rooms are pre-configured with shelves to provide the most efficient use of the available space (5 levels with approximately 470mm or 560mm of depth each, depending on chamber model). Also available stainless steel AISI 304 shelves as option.

[4] Additional trays/levels can be added to shelving configuration.

[5] Other volumes available. Please consult Aralab for bespoke rooms and special requirements.

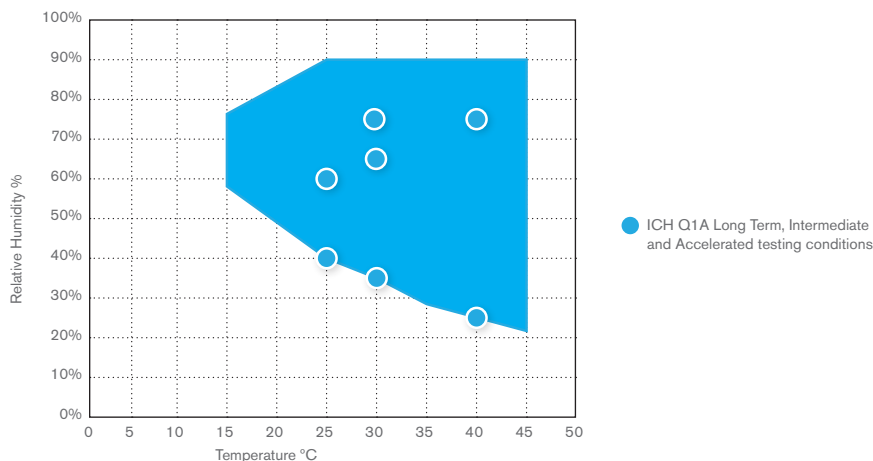

● ● ● ● HUMIDITY WORKING RANGE^[1]



[1] Range with standard performance. Temperature and Humidity range extensions are possible. Please consult Aralab with requirements.

DIMENSIONS AND DRAWINGS

● ● ● ● STABILCLIMA 5 000 PH

EXTERNAL DIMENSIONS (HxWxD) (mm)		2 610 x 2 225 x 2 200 (2 750 with door opening)
INTERNAL DIMENSIONS (HxWxD) (mm)		2 040 x 2 010 x 1 610

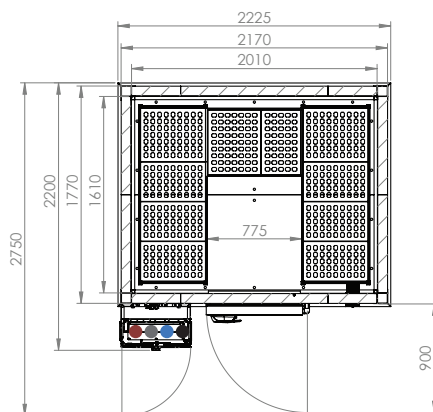
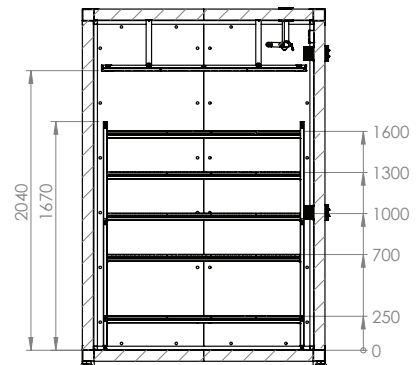
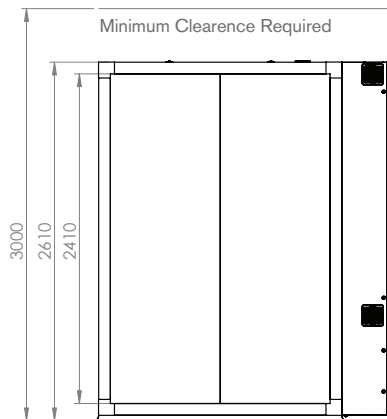
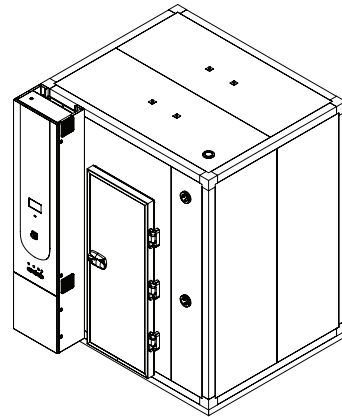
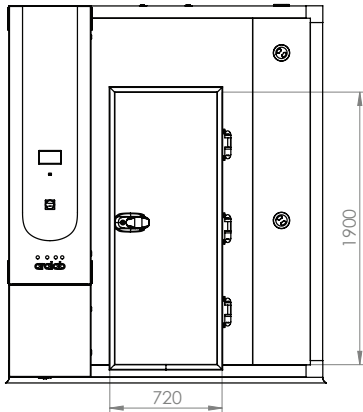

Condensing unit
Should be installed in the exterior, sheltered for direct sunlight, snow, rain or dust.

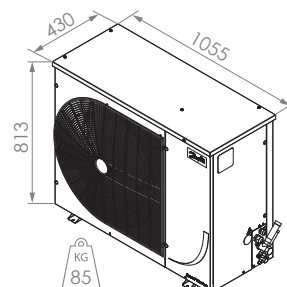



- Standard refrigeration system is air cooled.
- Services installation needs:
 - 3/4" demineralized water supply.
Conductivity: <math><50\mu\text{S}/\text{cm}</math>.
Pressure: 1-5 Bar.
Maximum water consumption: 2,1L/h.
 - 20mm water drain at floor level, female connection.

- Electrical cabinet installation needs:
 - Supply power: 400VAC, 50Hz (60Hz upon request), 15A / 3-Phase + Neutral + Ground.
Electrical protection: Circuit breaker 3 x 16A + N with 300mA differential.
3-Phase electrical cable RV-K 5G2.5 on the top.
 - RJ45 Ethernet socket communication port on the top.
- Equipment Weight (approximate): 660 kg.

DIMENSIONS AND DRAWINGS

● ● ● ● STABILCLIMA 12 000 PH

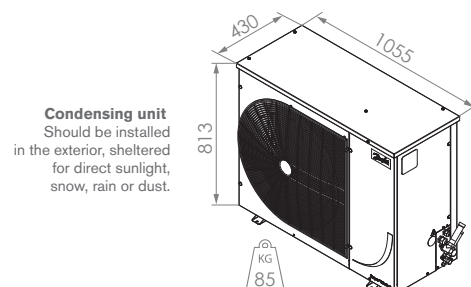
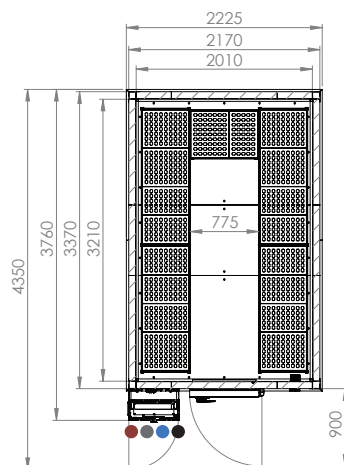
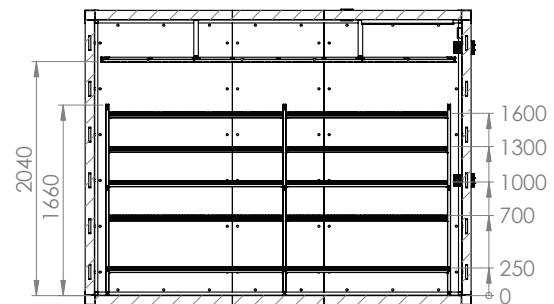
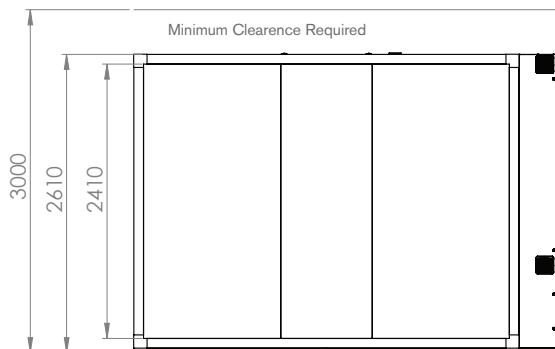
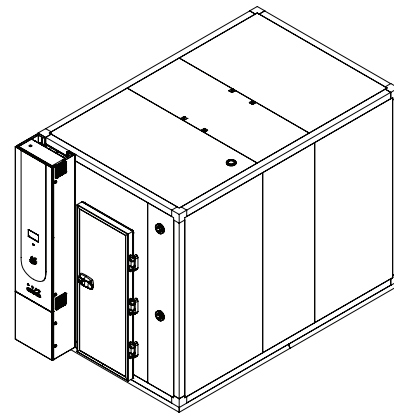
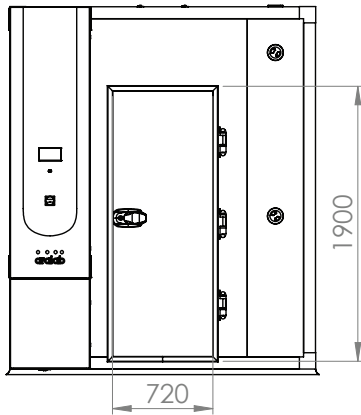

EXTERNAL DIMENSIONS (HxWxD) (mm)		2 610 x 2 225 x 3 760 (4 350 with door opening)
INTERNAL DIMENSIONS (HxWxD) (mm)		2 040 x 2 010 x 3 210



- Standard refrigeration system is air cooled.
- Services installation needs:
 - 3/4" demineralized water supply.
Conductivity: <math><50\mu\text{S}/\text{cm}</math>.
Pressure: 1-5 Bar.
Maximum water consumption: 2,1L/h.
 - 20mm water drain at floor level, female connection.
- Electrical cabinet installation needs:
 - Supply power: 400VAC, 50Hz (60Hz upon request), 15A / 3-Phase + Neutral + Ground.
Electrical protection: Circuit breaker 3 x 16A + N with 300mA differential 3-Phase electrical cable RV-K 5G2.5 on the top.
 - RJ45 Ethernet socket communication port on the top.
- Equipment Weight (approximate): 820 kg.

DIMENSIONS AND DRAWINGS

● ● ● ● STABILCLIMA 20 000 PH

EXTERNAL DIMENSIONS (HxWxD) (mm)		2 610 x 2 225 x 5 380 (5 950 with opened door)
INTERNAL DIMENSIONS (HxWxD) (mm)		2 040 x 2 010 x 4 800

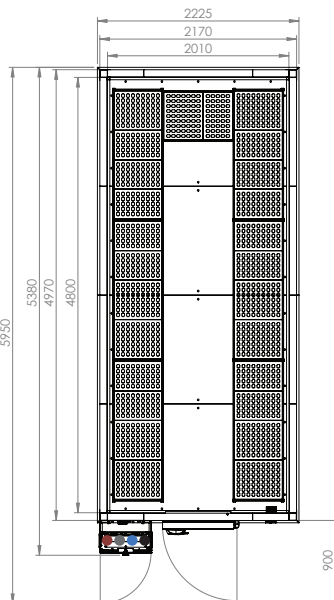
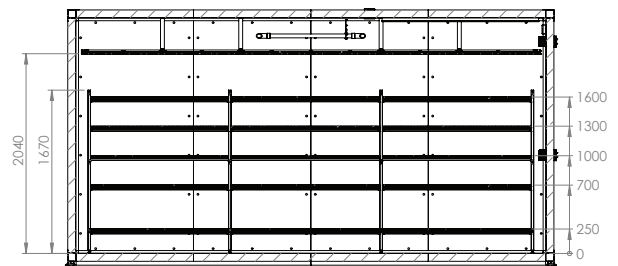
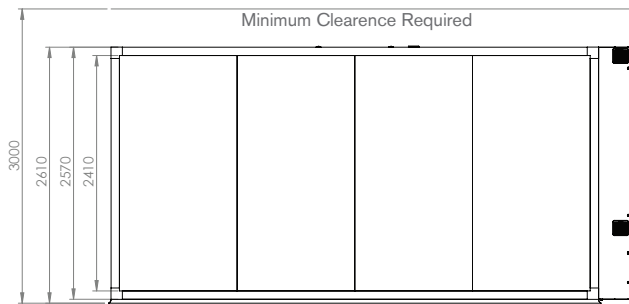
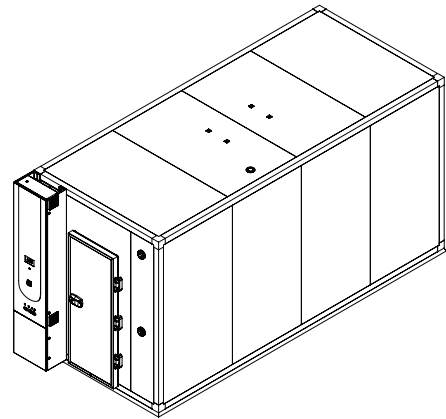
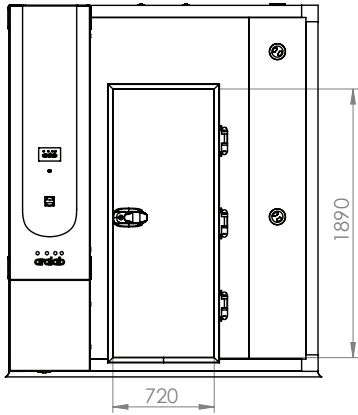

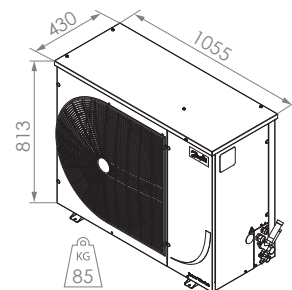

Condensing unit
Should be installed
in the exterior, sheltered
for direct sunlight,
snow, rain or dust.



- Standard refrigeration system is air cooled.
- Services installation needs:
 - 3/4" demineralized water supply.
 - Conductivity: <math>< 50 \mu\text{S}/\text{cm}</math>.
 - Pressure: 1-5 Bar.
 - Maximum water consumption: 2,1L/h.
 - 20mm water drain at floor level, female connection.
- Electrical cabinet installation needs:
 - Supply power: 400VAC, 50Hz (60Hz upon request), 15A / 3-Phase + Neutral + Ground.
 - Electrical protection: Circuit breaker 3 x 16A + N with 300mA differential.
 - 3-Phase electrical cable RV-K 5G2.5 on the top.
 - RJ45 Ethernet socket communication port on the top.
- Equipment Weight (approximate): 990 kg.

DIMENSIONS AND DRAWINGS

● ● ● ● STABILCLIMA 25 000 PH

EXTERNAL DIMENSIONS (HxWxD) (mm)		2 610 x 3 825 x 3 800 (4 350 with door opening)
INTERNAL DIMENSIONS (HxWxD) (mm)		2 040 x 3 610 x 3 210

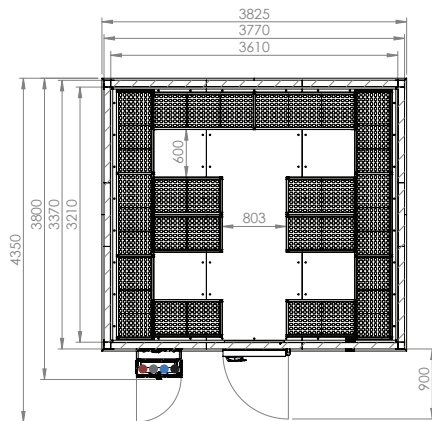
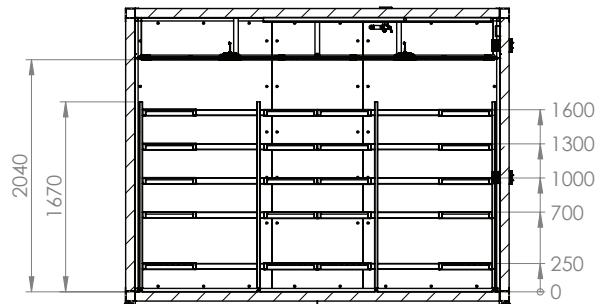
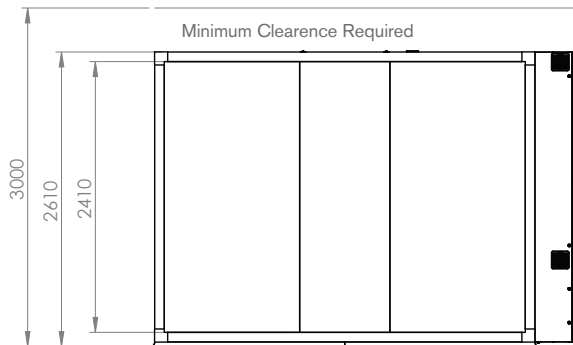
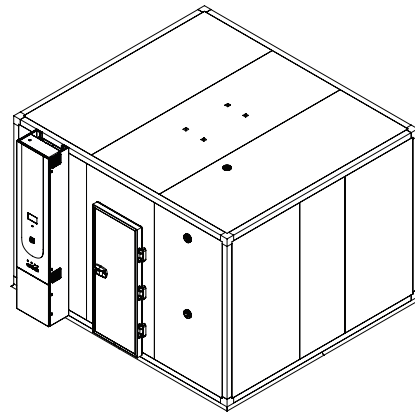
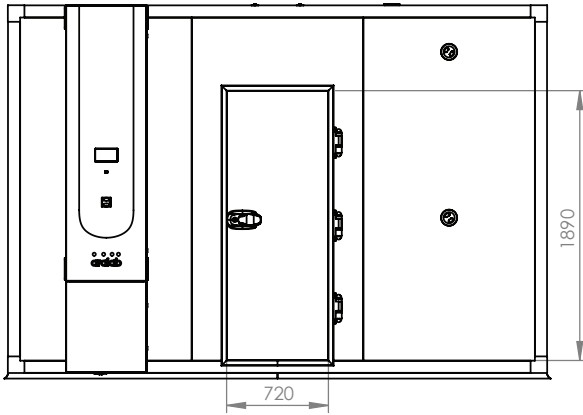

Condensing unit
Should be installed in the exterior, sheltered for direct sunlight, snow, rain or dust.

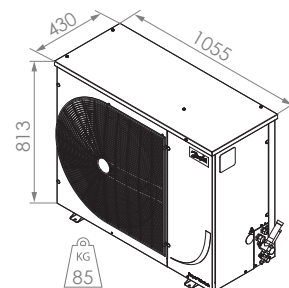

- Standard refrigeration system is air cooled.
- Services installation needs:
 - 3/4" demineralized water supply.
 - Conductivity: <math>< 50 \mu\text{S}/\text{cm}</math>.
 - Pressure: 1-5 Bar.
 - Maximum water consumption: 2,1L/h.
 - 20mm water drain at floor level, female connection.

- Electrical cabinet installation needs:
 - Supply power: 400VAC, 50Hz (60Hz upon request), 15A / 3-Phase + Neutral + Ground.
 - Electrical protection: Circuit breaker 3 x 16A + N with 300mA differential.
 - 3-Phase electrical cable RV-K 5G2.5 on the top.
 - RJ45 Ethernet socket communication port on the top.
- Equipment Weight (approximate): 1050 kg.

EQUIPMENT DESCRIPTION



CONSTRUCTION

- Exterior: EN 14509 sandwich type high density injected polyurethane foam modular panels, 80 mm thick (other thicknesses available for different specific insulation requirements) with galvanized steel in light gray plastic finish.
- Walls: Galvanized steel with white epoxy paint.
- Shelving and trays: standard in anodized aluminium structures with polyethylene trays (5 tiers); optional in highly resistant stainless steel.
- Floor: stainless steel slip resistant.
- Entry port Ø80mm.
- New generation multi-color touch-screen ClimaPlus© controller.
- Door with double gasket, key lock and safety opening mechanism from the inside.
- Open door alarm with configurable time-out function.
- Free slots for connecting and integrating external devices with the controller.



CLIMATIC CONTROL

- Air-cooled mechanical refrigeration by hermetic condenser group. (Water-cooled condenser also possible).
- Dual heating technology with hot gas by-pass and stainless steel electric heaters.
- Humidification by means of highly efficient 'micro' steam humidity generator. Alternatively, ultrasonic humidity generators can also be used.
- Dehumidification by condensation on the cooling system evaporator.



AIR FLOW

- Dynamic airflow with EC (variable) blower.
- Forced in horizontal and downward direction.
- Horizontal airflow across the shelves to assure uniformity to all storage area.
- Air renovation through adjustable lateral port-holes.
- Airflow velocity adjustable at the ClimaPlus© controller.

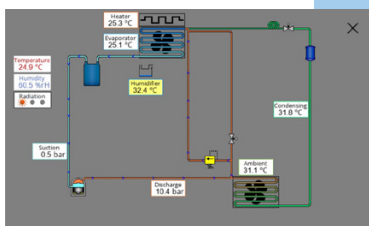

CONTENT PROTECTION AND AUTOMATIC DIAGNOSTICS

- Independent thermostats for maximum and minimum temperature limits.
- Automatic cut-off function, in case of excessive heating or cooling.
- Configurable maximum and minimum temperature and humidity limits.
- Visual and audible alarms for temperature and humidity limits.
- Synoptic diagram function: a self-diagnostics tool that checks all active components of the system allowing for faster procedures and minimizing any possible downtimes.

CLIMAPLUS CONTROLLER HMI

- Programmable Logic Controller exclusively developed by Aralab for Aralab chambers.
- Multi-language, easy-to-use touch-screen interface (EN, FR, DE, IT, PT, ES and other languages on request).
- 90mm x 155mm (7 inch) multicolor display.
- Controls every environmental variable available for any specific StabilClima model (Temperature, Humidity, Lights, Airflow, CO₂ and connected external devices).
- Friendly program editor for creating 32 programs of 24 segments each, allowing the design of complex and comprehensive climatic simulation programs.
- Password protection of the controller functions.
- Content and research protection feature, with configurable High and Low Temperature and Humidity alarms and automatic notifications.
- Managing, monitoring and recording of all alarms.
- Non-volatile memory, allowing the automatic restart of previously defined set-points or ongoing programs due to power failure, without losing data.
- Real-time monitoring of all the functions and active components of the equipment, allowing for a fast and accurate diagnostic in case of malfunction.
- Possibility to control and program events by external commands and with external devices.
- Graphical view of programs and climatic variables.
- Ethernet and Wi-Fi for connecting computers to the controller.
- ClimaPlus controller functions also available at the PC/Laptop with the FitoLog software pack.

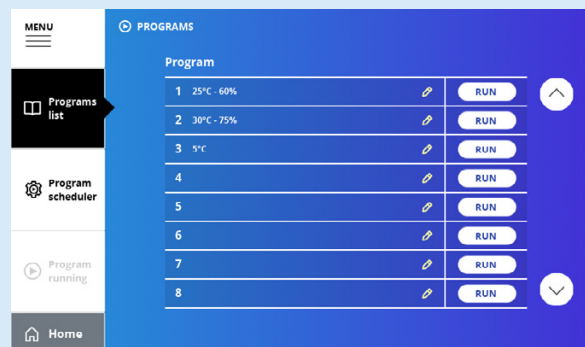
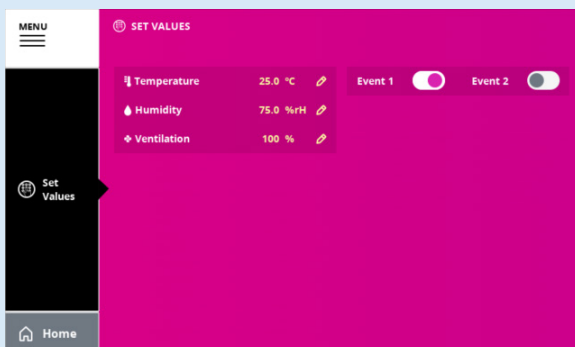
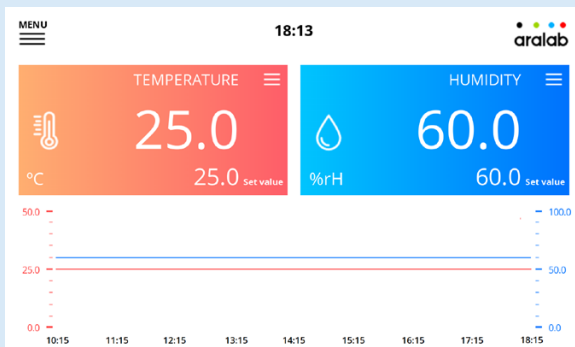

FITOLOG SOFTWARE GAMP 5

The FitoLog software pack - FDA 21 CFR part 11 and Eudralex compliant according to GAMP5 risk based approach - is a set of applications designed to facilitate the programming, monitoring, managing and recording of programs and data from the StabiClima chambers. It consists of 3 applications: **FitoLog**, **FitoLogView** and **FitoProgram**.



FITOLOG

Displays and records in real time all data and details related to the set-points, running variables and equipment behaviour. It also retrieves information about the active components of the chamber, running processes, errors, alarms and allows the configuration of periodic or alarm triggered remote notifications (by email or SMS, depending on existing connections and accessories).

User Access Levels can be managed and configured (exclusive for FitoLog FDA 21CFR part11 compliant version)



FITOLOGVIEW

It is a working tool to process data recorded by the FitoLog program. One can view, print and export the log contents to other file types, and analyse the data in other data management software.

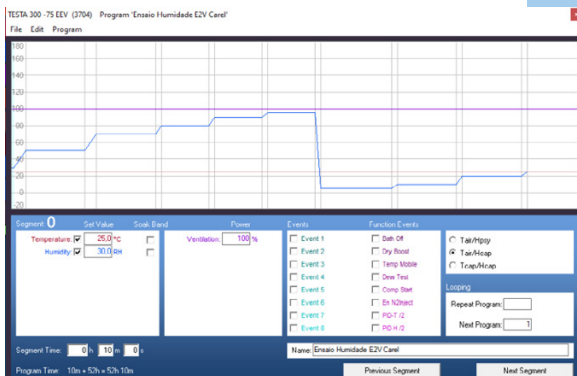

FITOPROGRAM

This application simplifies the creation of programs and its integration on the chamber ClimaPlus controller. Up to 32 programs, each with 24 segments, can be designed and linked to create detailed environmental profiles and simulations.

CONTENT SECURED WITH ALARMS, NOTIFICATIONS, FAST DIAGNOSTICS AND PROMPT TROUBLESHOOTING

With FitoLog it is possible to gather data from each of the chambers systems, which makes it a very useful tool to diagnose any necessary maintenance. This tool works as the "black box" of the equipment, giving Aralab technicians the necessary data to remotely carry out a fast and efficient diagnostic. All that is needed is a FitoLog file.

COMMON ACCESSORIES

PLEASE CONSULT ARALAB FOR OTHER ITEMS

FitoLog® software pack for PC/Laptops, enabling data monitoring and logging (FDA 21 CFR part 11 compliant).

IQ, OQ, PQ documentation.

Additional temperature and humidity sensors.

Additional shelves and racks.

Shelves in AISI 304 stainless steel.

Observation window on the door.

Refrigeration and Humidification redundancy.

Additional entry port.

Extended temperature ranges.

Integrated water tank with electric pump and security valve.

Energy e-meter.

5 stage Reverse Osmosis with pre-decalcification water treatment system.

Internal electrical connection sockets.



Water treatment systems



Additional tiers of shelves

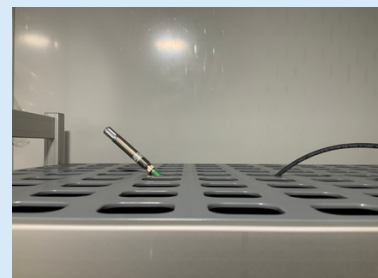

Additional sensors / loggers

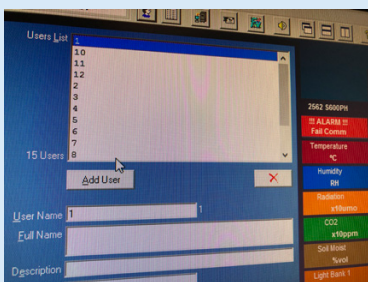

FDA 21CFR part11 software



Back-up redundant systems

ARALAB STABILITY - CUSTOMER APPLICATIONS

CUSTOMER SPECIFICATIONS AND ACCESSORIES MAY RESULT IN DIFFERENT PRODUCT IMAGES)



ARALAB STABILCLIMA 25.000 PH
PHARMACEUTICAL PRODUCTS LONG TERM TESTING



STAINLESS STEEL SHELVING WITH 9 RACKS
FOR MAXIMUM STORAGE CAPACITY



STABILITY ROOMS TURNKEY PROJECT BY ARALAB



SIX TIER SHELVING IN ANODIZED ALUMINIUM
WITH POLYETHYLENE TRAYS



SET OF 8 X STABILCLIMA STABILITY ROOMS
AT A STABILITY SERVICES COMPANY



INTERIOR OF STABILCLIMA 12.000PH RUNNING
AT 30°C / 75%rH

Features and specifications are subject to change. Aralab continuously studies ways to further develop its products to achieve better performances and overall product quality. As a result, characteristics and specifications provided in this document may be subject to changes.

Let's meet!

aralab@aralab.pt

www.aralab.pt

T: +351 219 154 960



[Configure your chamber](#)

[See it on the Showroom](#)

[f/AralabChambers](#)

[in/company/aralab](#)

[v/user/AralabChambers](#)

[✉/Aralab_](#)

[@aralabchambers](#)



Control the environment
Your own climate